



# DISPLAY 9000

Dekorative Nothinweisleuchte  
aus hochwertigem Edelstahl  
in LED-Technik

# 24m

DISPLAY 9000	EVG-Version	Akku-Version	Optional
ERKENNUNGSWEITE / viewing distance	24m		<ul style="list-style-type: none"> <li>Betoneingießstopf / concrete ceiling box</li> </ul> <p>DG6_BET</p>
GEHÄUSEMATERIAL / housing material	Edelstahl / stainless steel		
OBERFLÄCHE / surface	gebürstet / brushed		
LEUCHTMITTEL / illuminant	LED		
LEISTUNG (AC/DC) / load (AC/DC)	5,9VA / 2,8W	–	
SPANNUNG / voltage	230V AC/DC	230V AC	
NiMH-AKKU / NiMH-battery	–	4,8V - 0,8Ah	
LICHT (Netz/Not) / luminous (mains/emergency)	100%	50%	
SCHUTZART / protection category	IP 41		
SCHUTZKLASSE / protection class	I		
ARTIKELNUMMER / article number	D90		

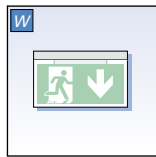

**Wandmontage**  
wall mounting

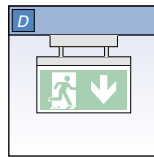

**Deckenmontage**  
ceiling mounting

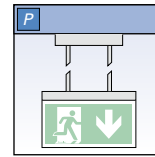

**Pendelmontage**  
pendulum mounting

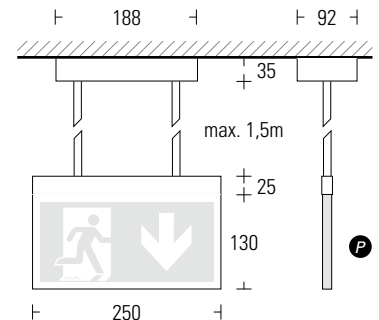
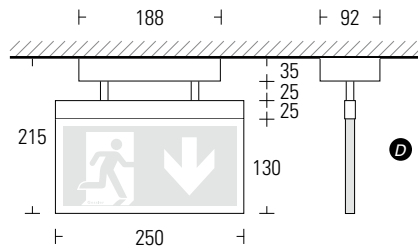
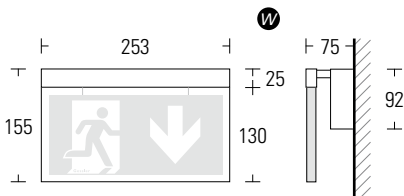

EVG-Version				Akku-Version				
ohne Überwachung without monitoring	mit Überwachung with monitoring	DALI-Überwachung DALI-monitoring	Kino-Ausführung Theatre version	1h	3h	8h	Auto-Check auto-test	BUS-Check BUS-test
•	•	•	• <small>Lichtstrom im Netzbetrieb 10%</small>	•*	•*	–	•*	•*

\*) Nicht mit integrierter Bereitschaftsleuchte verfügbar.

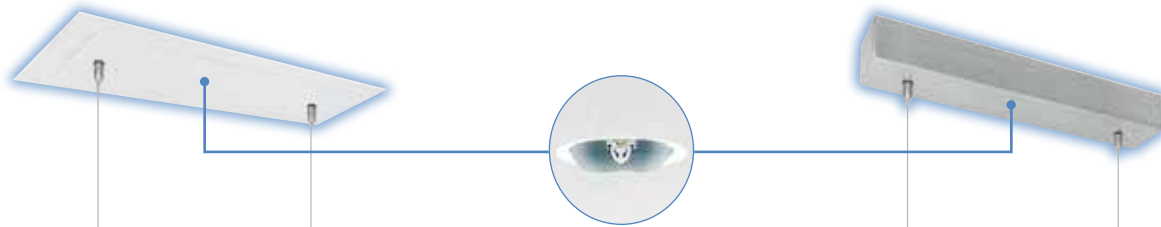

**Optional:**  
 Mit integrierter Bereitschaftsleuchte.  
 Lichttechnik identisch mit LED-Spot LA5  
 (nur als EVG Version)

# DESIGN PLUS

participate 2012



**Besonderheit:**  
 Spannversorgung über  
 Seilabhängung

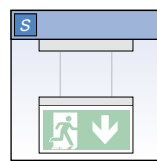
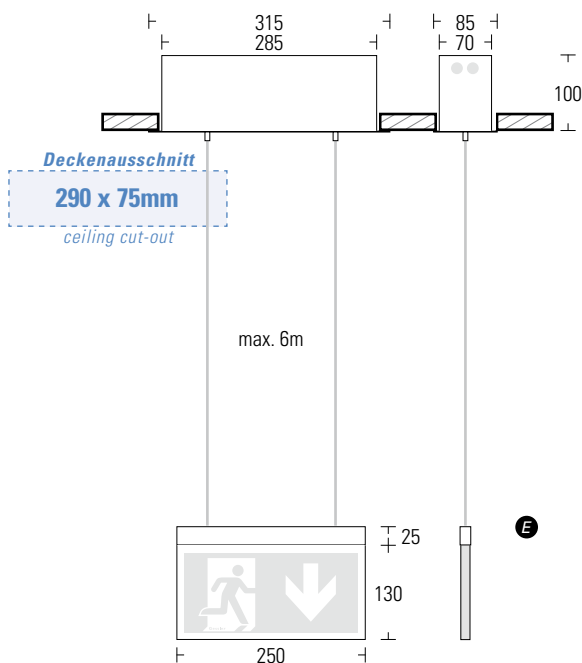

**Seillaufbau**  
 rope mounting

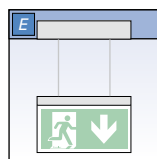

**Seileinbau**  
 recessed rope mounting

