

LUMINA

2000/5 - 2000/7 - 2000/8 - 2000/17

Nothinweisleuchten aus Alu-Profil

| LUMINA | 2000/5 EVG | 2000/7 EVG | 2000/7 Akku |
|------------------------------------|-------------------------|-------------------------|----------------------|
| ERKENNUNGSWEITE / viewing distance | 18m | 27m | |
| GEHÄUSEMATERIAL / housing material | Aluminium | Aluminium | |
| GEHÄUSEFARBE / housing colour | RAL 9016 (weiß / white) | RAL 9016 (weiß / white) | |
| LEUCHTMITTEL / illuminant | LED | LED | |
| LEISTUNG (AC/DC) / load (AC/DC) | 6,2VA / 2,6W | 7,6VA / 3,6W | - |
| SPANNUNG / voltage | 230V AC/DC | 230V AC/DC | 230V AC |
| NiCd-AKKU / NiCd-battery | - | - | 3,6V - 2,5Ah (1h/3h) |
| SCHUTZART / protection category | IP 40 | IP 40 | |
| SCHUTZKLASSE / protection class | I | I | |
| ARTIKELNUMMER / article number | L05 | L07 | |

| EVG-Version | | | |
|---|---|--|---|
| ohne Überwachung <i>without monitoring</i> | mit Überwachung <i>with monitoring</i> | DALI-Überwachung <i>DALI-monitoring</i> | Kino-Ausführung <i>Theatre version</i> |
| L05 | L05 | L05 | L05 |
| L07 | L07 | L07 | L07 |
| L08 | L08 | L08 | L08 |
| L17 | L17 | L17 | L17 |

Lichtstrom im Netzbetrieb 10%

| Akku-Version | | | | |
|--------------|-----|-----|--------------------------------|------------------------------|
| 1h | 3h | 8h | Auto-Check <i>auto-test</i> | BUS-Check <i>BUS-test</i> |
| L07 | L07 | L07 | L07 | L07 |
| L08 | L08 | L08 | L08 | L08 |
| L17 | L17 | L17 | L17 | L17 |

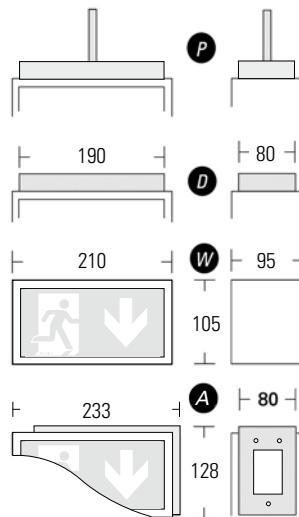

Typ Lumina 2000/5

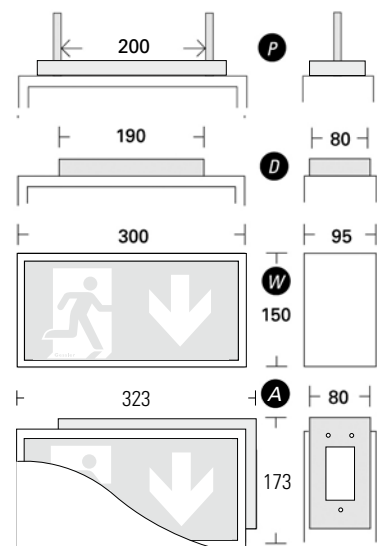

Typ Lumina 2000/7

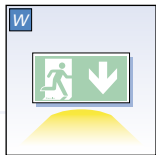

Wandmontage
wall mounting

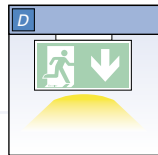

Deckenmontage
ceiling mounting

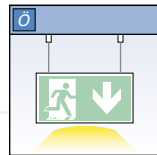

Ösenmontage
ear mounting

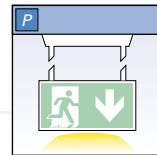

Pendelmontage
pendulum mounting

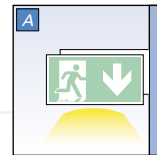

Wandausleger
wall bracket mounting

| 2000/8 EVG | | 2000/8 Akku | | 2000/17 EVG | | 2000/17 Akku | | Optional |
|-------------------------|--|----------------------|--|-------------------------|--|--------------------|--|---|
| 38m | | | | 56m | | | | <ul style="list-style-type: none"> • Ballschutzgitter / ball protection grill EVG-Version: <ul style="list-style-type: none"> • Überwachung / monitoring Akku-Version: <ul style="list-style-type: none"> • BUS-Check / BUS-test • Auto-Check / auto-test  inkl. Piktogramm-Set (IPU/IPR/IPL) (gilt nicht für Lumina 2000/17) |
| Aluminium | | | | Aluminium | | | | |
| RAL 9016 (weiß / white) | | | | RAL 9016 (weiß / white) | | | | |
| LED | | | | LED | | | | |
| 7,6VA / 3,6W | | - | | 10,1VA / 4,5W | | - | | |
| 230V AC/DC | | 230V AC | | 230V AC/DC | | 230V AC | | |
| - | | 3,6V - 2,5Ah (1h/3h) | | - | | 3,6V - 4Ah (1h/3h) | | |
| IP 40 | | | | IP 40 | | | | |
| I | | | | I | | | | |
| L08 | | | | L17 | | | | |

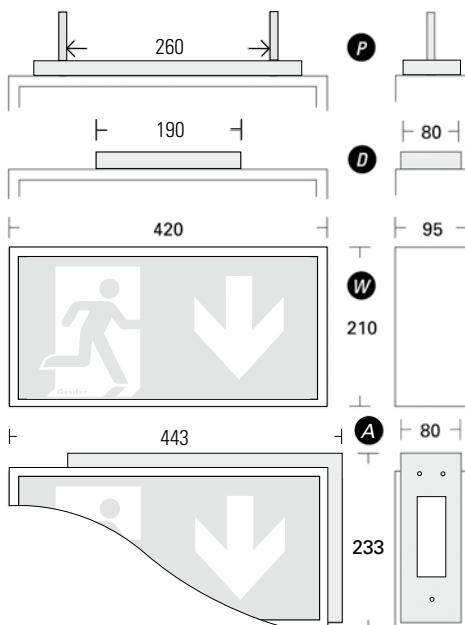

Typ Lumina 2000/8

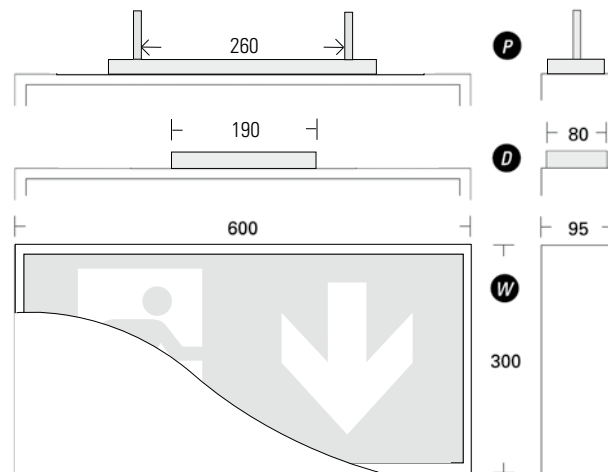

Typ Lumina 2000/17