

Lumina

2000/16

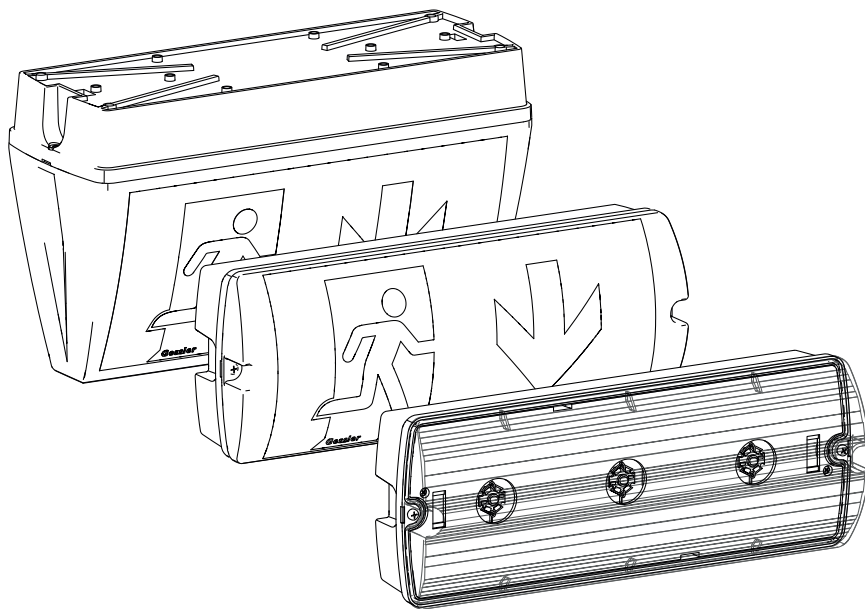

MONTAGEANLEITUNG

Assembly instructions

1.

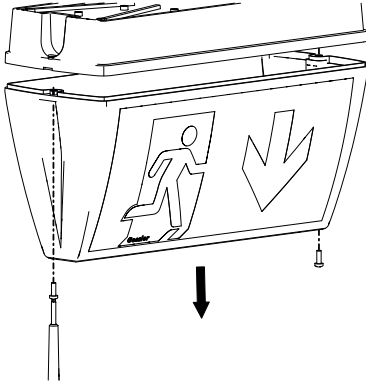

2.

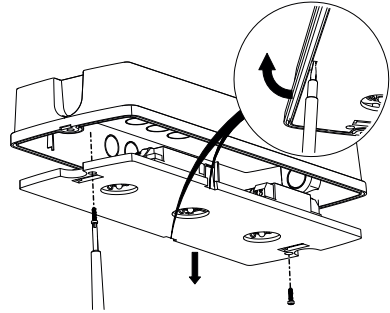

3.

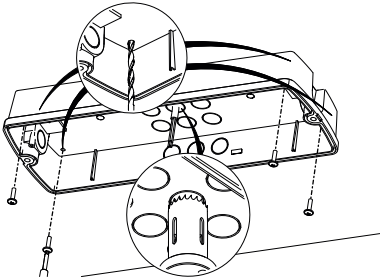

4.

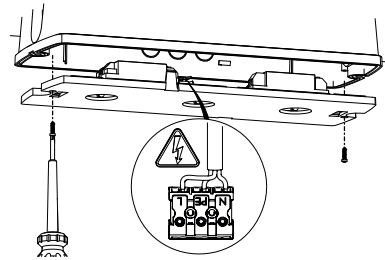

5.

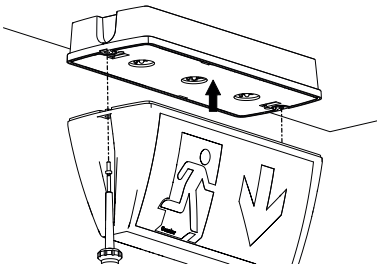

6.

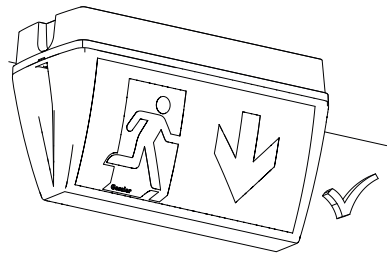

1.

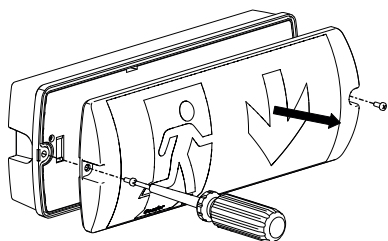

2.

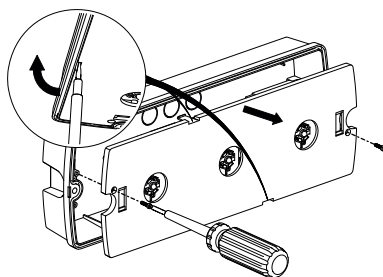

3.

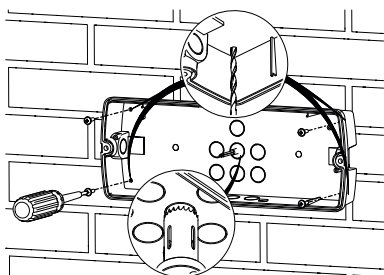

4.

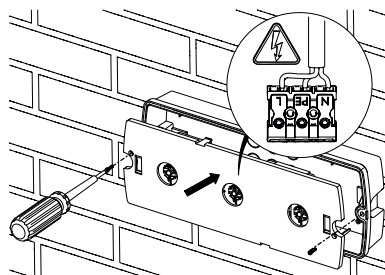

5.

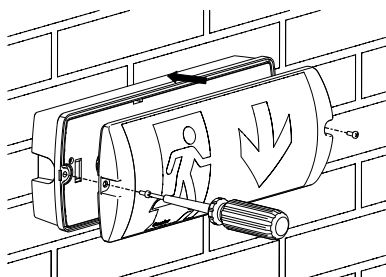

6.

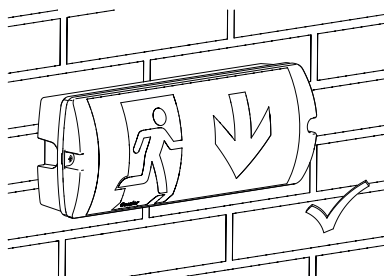

Deckenmontage / ceiling mounting

1.

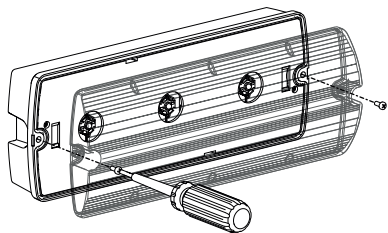

2.

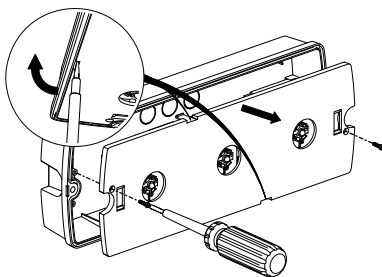

3.

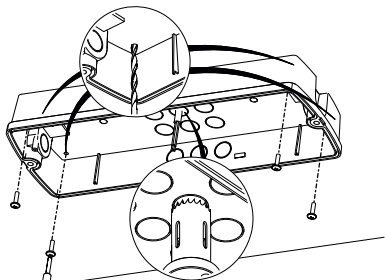

4.

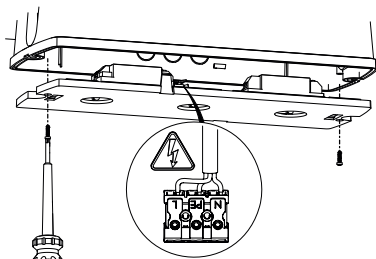

5.

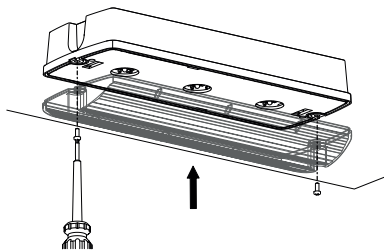

6.

